

BL 8
corner angle, KHI

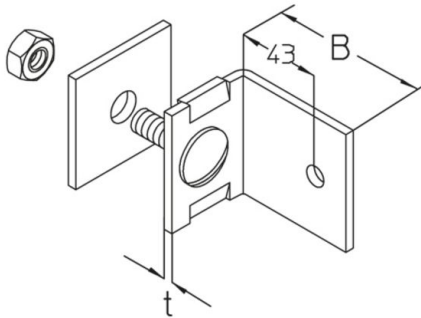

Hot-dip galvanized, according to BS 729 (DIN EN ISO 1461)

Product	H	B	t	G
BL 8F	50 mm	58 mm	4,00 mm	0,2 kg
incl.:				
1x FRS 10X30F		round-head screw with square, DIN 603		
1x SEM 10F		hexagon-nut, DIN 934		
1x RUS 50-L13F		washer, KHI		

H: height
B: width
t: material thickness
G: weight

DETAILS / APPLICATIONS



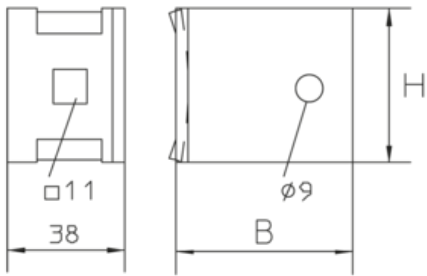

OPTIONAL ACCESSORIES

SD

