

GTR 60

mesh cable tray separating strip, height = 50 mm

mesh cable tray separating strip including clamp

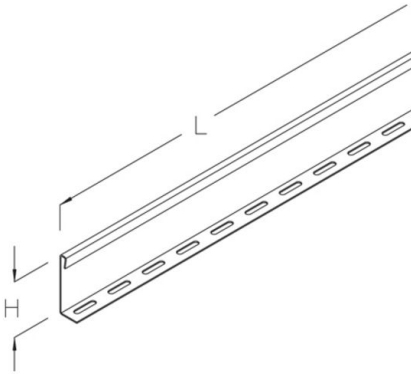

Continuously hot galvanized (Sendzimir process) (DIN EN 10346)

Product	H	L	G
GTR 60S	50 mm	3000 mm	2,07 kg
incl.:			
3x KLU-L F	Lug for KLU		
3x FRSV 6X16	round-head screw with short square, DIN 603		
3x SEMS 6	hexagon-nut with flange, DIN EN 1661		

Hot-dip galvanized, according to BS 729 (DIN EN ISO 1461)

Product	H	L	G
GTR 60F	50 mm	3000 mm	2,22 kg
incl.:			
3x KLU-L F	Lug for KLU		
3x FRSV 6X16E	round-head screw with short square, DIN 603		
3x SEMS 6E	hexagon-nut with flange, DIN EN 1661		

Stainless steel, according to ASTM 304 / BS 304 S 3

Product	H	L	G
GTR 60E	50 mm	3000 mm	2,09 kg



Product	H	L	G
incl.: 3x KLU-L E 3x FRSV 6X16E 3x SEMS 6E			
		Lug for KLU round-head screw with short square, DIN 603 hexagon-nut with flange, DIN EN 1661	

Stainless steel, according to ASTM 31 Ti / AISI 316 L, BS 320S17 / BS 316S11

Product	H	L	G
GTR 60E4	50 mm	3000 mm	2,11 kg
incl.: 3x SEM 6E4 3x KLU-L E4 3x FKS 6X16E4 3x US 6X12E4		hexagon-nut, DIN 934 Lug for KLU slotted cylinder head screw, DIN EN ISO 1580 washer, DIN EN ISO 7089	

H: height
L: length
G: weight

DETAILS / APPLICATIONS

