

STR 50

vertical ladder separating strip, height = 33 mm

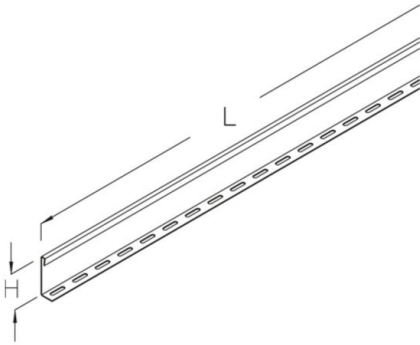

Continuously hot galvanized (Sendzimir process) (DIN EN 10346)

Product	H	L	G
STR 50S	33 mm	3000 mm	1,62 kg

Hot-dip galvanized, according to BS 729 (DIN EN ISO 1461)

Product	H	L	G
STR 50F	33 mm	3000 mm	1,78 kg

Stainless steel, according to ASTM 304 / BS 304 S 3

Product	H	L	G
STR 50E	33 mm	3000 mm	1,65 kg

H: height
L: length
G: weight

