

WPBP 150

wide-span attachment branch, height = 150 mm

Welded construction. Formed components must be supported at all sides. The following radii are available on request: 300 mm, 600 mm, 900 mm.

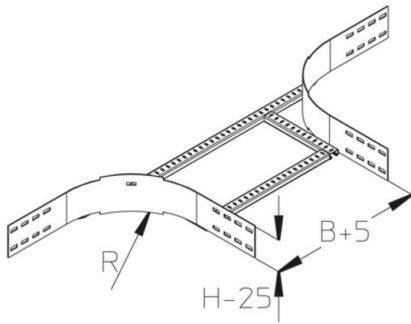

Hot-dip galvanized, according to BS 729 (DIN EN ISO 1461)

Product	H	B	R	G
WPBP15-20-45-HDG	150 mm	200 mm	450 mm	11,85 kg
incl.: 8x KLS 10X20-HDG		clamp fastening set		
WPBP15-30-45-HDG	150 mm	300 mm	450 mm	12,21 kg
incl.: 8x KLS 10X20-HDG		clamp fastening set		
WPBP15-40-45-HDG	150 mm	400 mm	450 mm	12,57 kg
incl.: 8x KLS 10X20-HDG		clamp fastening set		
WPBP15-45-45-HDG	150 mm	450 mm	450 mm	12,75 kg
incl.: 8x KLS 10X20-HDG		clamp fastening set		
WPBP15-50-45-HDG	150 mm	500 mm	450 mm	12,93 kg
incl.: 8x KLS 10X20-HDG		clamp fastening set		
WPBP15-60-45-HDG	150 mm	600 mm	450 mm	13,29 kg
incl.: 8x KLS 10X20-HDG		clamp fastening set		
WPBP15-70-45-HDG	150 mm	700 mm	450 mm	13,65 kg
incl.: 8x KLS 10X20-HDG		clamp fastening set		
WPBP15-75-45-HDG	150 mm	750 mm	450 mm	13,83 kg





Product	H	B	R	G
incl.: 8x KLS 10X20-HDG				
			clamp fastening set	
WPBP15-80-45-HDG	150 mm	800 mm	450 mm	14,01 kg
incl.: 8x KLS 10X20-HDG				
			clamp fastening set	
WPBP15-90-45-HDG	150 mm	900 mm	450 mm	14,37 kg
incl.: 8x KLS 10X20-HDG				
			clamp fastening set	
WPBP15-100-45-HDG	150 mm	1000 mm	450 mm	14,73 kg
incl.: 8x KLS 10X20-HDG				
			clamp fastening set	

Stainless steel, according to ASTM 304 / BS 304 S 3

Product	H	B	R	G
WPBP15-20-45-304	150 mm	200 mm	450 mm	11,85 kg
incl.: 8x KLS 10X20-304				
			clamp fastening set	
WPBP15-30-45-304	150 mm	300 mm	450 mm	12,21 kg
incl.: 8x KLS 10X20-304				
			clamp fastening set	
WPBP15-40-45-304	150 mm	400 mm	450 mm	12,57 kg
incl.: 8x KLS 10X20-304				
			clamp fastening set	
WPBP15-45-45-304	150 mm	450 mm	450 mm	12,75 kg
incl.: 8x KLS 10X20-304				
			clamp fastening set	
WPBP15-50-45-304	150 mm	500 mm	450 mm	12,93 kg
incl.: 8x KLS 10X20-304				
			clamp fastening set	
WPBP15-60-45-304	150 mm	600 mm	450 mm	13,29 kg
incl.: 8x KLS 10X20-304				
			clamp fastening set	
WPBP15-70-45-304	150 mm	700 mm	450 mm	13,65 kg





Product	H	B	R	G
incl.: 8x KLS 10X20-304			clamp fastening set	
WPBP15-75-45-304	150 mm	750 mm	450 mm	13,83 kg
incl.: 8x KLS 10X20-304			clamp fastening set	
WPBP15-80-45-304	150 mm	800 mm	450 mm	14,01 kg
incl.: 8x KLS 10X20-304			clamp fastening set	
WPBP15-90-45-304	150 mm	900 mm	450 mm	14,37 kg
incl.: 8x KLS 10X20-304			clamp fastening set	
WPBP15-100-45-304	150 mm	1000 mm	450 mm	14,73 kg
incl.: 8x KLS 10X20-304			clamp fastening set	

Stainless steel, according to ASTM 31 Ti / AISI 316 L, BS 320S17 / BS 316S11

Product	H	B	R	G
WPBP15-20-45-316	150 mm	200 mm	450 mm	11,85 kg
incl.: 8x KLS 10X20-316			clamp fastening set	
WPBP15-30-45-316	150 mm	300 mm	450 mm	12,21 kg
incl.: 8x KLS 10X20-316			clamp fastening set	
WPBP15-40-45-316	150 mm	400 mm	450 mm	12,57 kg
incl.: 8x KLS 10X20-316			clamp fastening set	
WPBP15-45-45-316	150 mm	450 mm	450 mm	12,75 kg
incl.: 8x KLS 10X20-316			clamp fastening set	
WPBP15-50-45-316	150 mm	500 mm	450 mm	12,93 kg
incl.: 8x KLS 10X20-316			clamp fastening set	
WPBP15-60-45-316	150 mm	600 mm	450 mm	13,29 kg



Product	H	B	R	G
incl.: 8x KLS 10X20-316				clamp fastening set
WPBP15-70-45-316	150 mm	700 mm	450 mm	13,65 kg
incl.: 8x KLS 10X20-316				clamp fastening set
WPBP15-75-45-316	150 mm	750 mm	450 mm	13,83 kg
incl.: 8x KLS 10X20-316				clamp fastening set
WPBP15-80-45-316	150 mm	800 mm	450 mm	14,01 kg
incl.: 8x KLS 10X20-316				clamp fastening set
WPBP15-90-45-316	150 mm	900 mm	450 mm	14,37 kg
incl.: 8x KLS 10X20-316				clamp fastening set
WPBP15-100-45-316	150 mm	1000 mm	450 mm	14,73 kg
incl.: 8x KLS 10X20-316				clamp fastening set

H: height
B: width
R: radius
G: weight

DETAILS / APPLICATIONS

