

WPCH 150

wide-span connector, horizontally adjustable, height = 150 mm

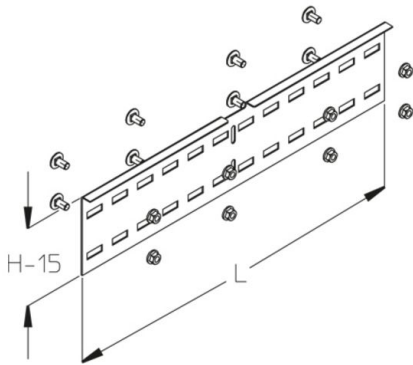

Hot-dip galvanized, according to BS 729 (DIN EN ISO 1461)

Product	H	L	G
WPCH15-HDG	150 mm	600 mm	1,91 kg
incl.:			
8x KLS 10X20-HDG		clamp fastening set	

Stainless steel, according to ASTM 304 / BS 304 S 3

Product	H	L	G
WPCH15-304	150 mm	600 mm	1,70 kg
incl.:			
8x KLS 10X20-304		clamp fastening set	

Stainless steel, according to ASTM 31 Ti / AISI 316 L, BS 320S17 / BS 316S11

Product	H	L	G
WPCH15-316	150 mm	600 mm	1,72 kg
incl.:			
8x KLS 10X20-316		clamp fastening set	

H: height



L: length
G: weight

DETAILS / APPLICATIONS

