

## RAE 35

Aanbouwhoek kabelgoot, hoogte = 35 mm

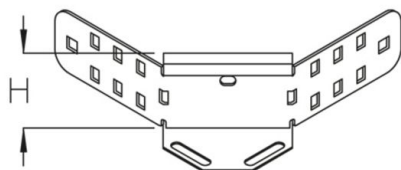

### Continu thermisch verzinkt (Senzimir-techniek) (DIN EN 10346)

Product	H	G
RAE 35S	35 mm	0,15 kg

### Thermisch verzinkt volgens BS 729 (DIN EN ISO 1461)

Product	H	G
RAE 35F	35 mm	0,17 kg

**H:** hoogte  
**G:** gewicht

## DETAILS / TOEPASSINGEN



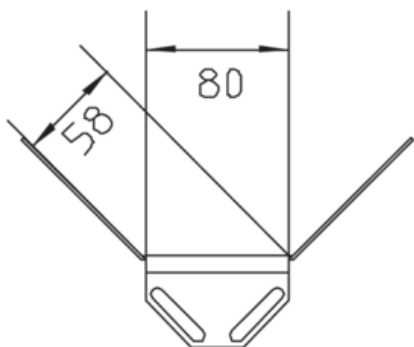

## OPTIONELE TOEBEHOREN

VB, RTRV 35

